

Quantum coherence and dissipation

Aspen, February 2002

Subir Sachdev

Organizers:

Aharon Kapitulnik and Eugene Demler

Talk online at
<http://pantheon.yale.edu/~subir>



Outline

- I. Single qubits with vanishing dissipation.
(*Tsai, Lukens, Barbara, Sarachik*)
- II. Single qubits with controlled dissipation.
(*Paalanen, Haviland, Demler, Chakravarty, Chudnovsky*)
- III. Quantum phase transitions of coupled qubits.
(*Kasevich, Zoller, Rosenbaum*)
- IV. Quantum phase transitions of systems with microscopic dissipation.
(*Shimshoni, Chakravarty, Demler*)
- V. Superconductor-metal-insulator and quantum-Hall transitions.
(*Tinkham, Kravchenko, Goldman, Mason, Shahar*)
- VI. Decoherence in metals.
(*Marcus, Gershenson, Birge, Willett*)
- VII. Other talks.
(*Cirac, Lukin, Clarke, Chemla, Yamamoto*)
- VIII. Conclusions

I. Single qubits with vanishing dissipation.

(Tsai, Lukens, Barbara, Sarachik)

Superconducting Qubit

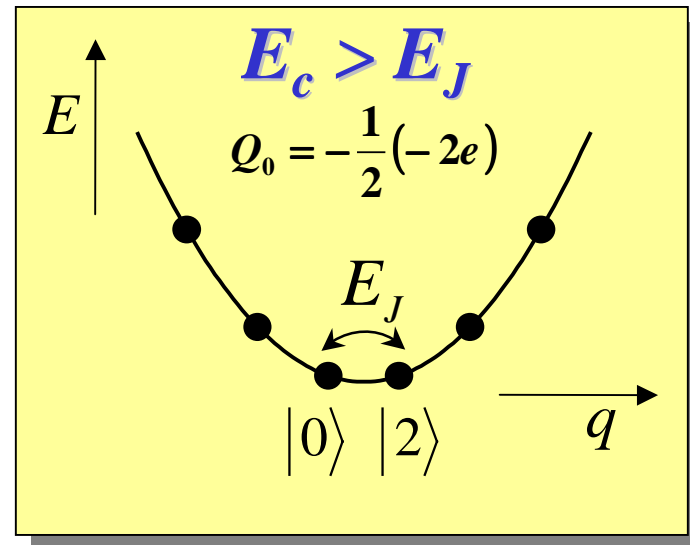
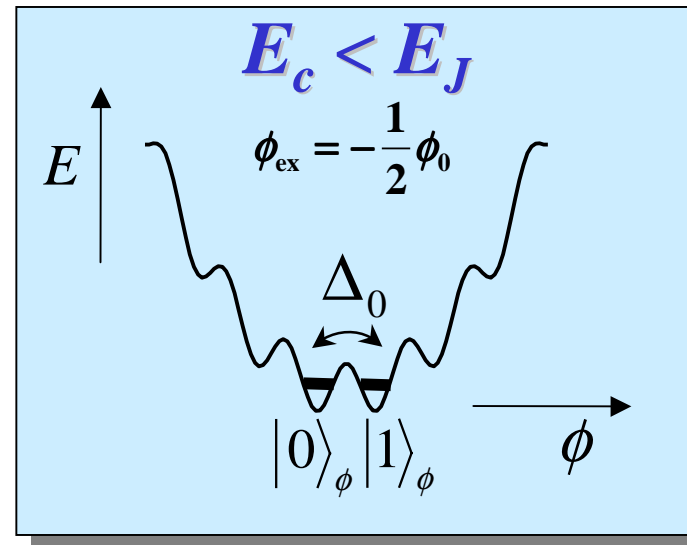
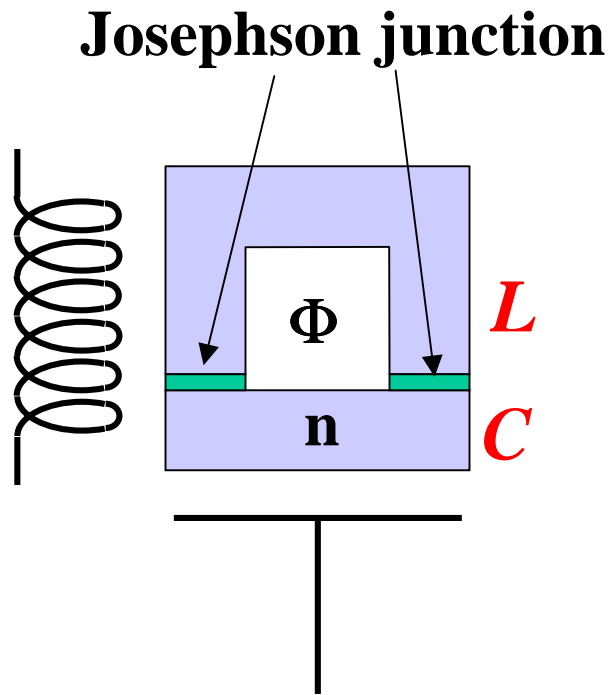

Time Domain Experiment

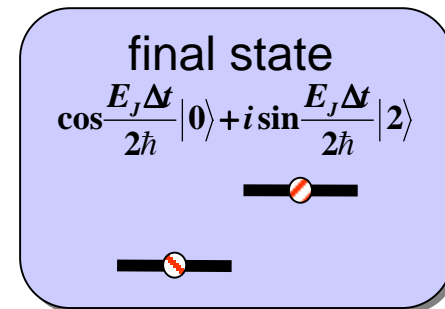
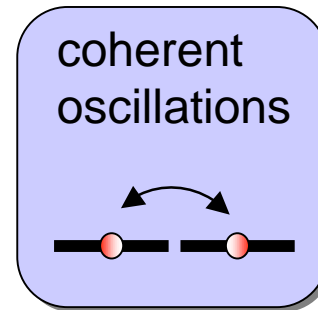
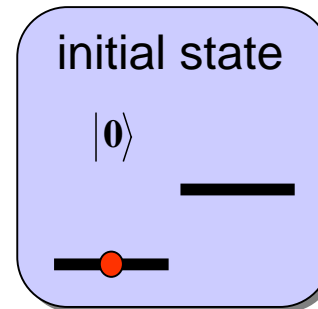
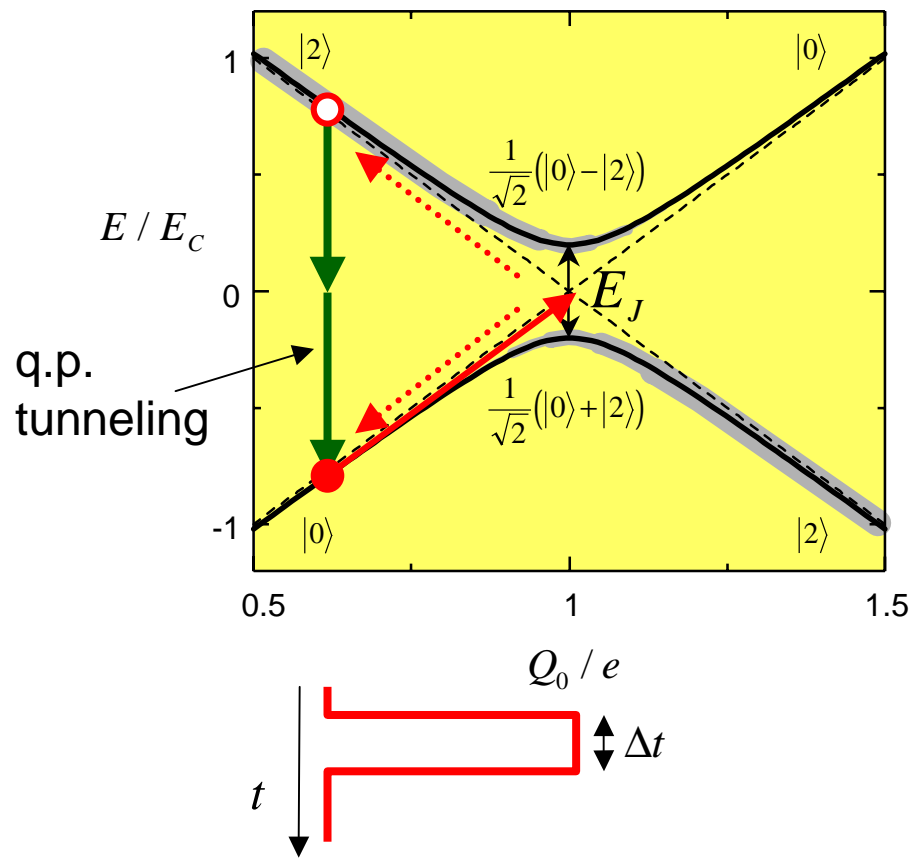

Non-adiabatic gate operation

Observation of Coherent Superposition of Macroscopic States

Jonathan Friedman, Vijay Patel, Wei Chen, Sergey Tolpygo and James Lukens

The SQUID

(Superconducting QUantum Interference Device)

•SQUIDs like integer flux quanta, Φ_0

$$\Phi_x \approx \frac{1}{2} \Phi_0$$

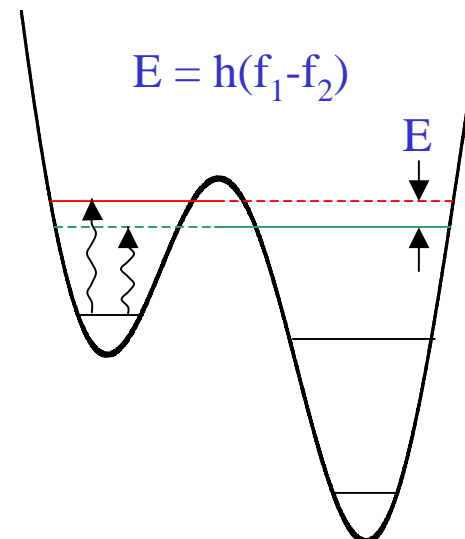
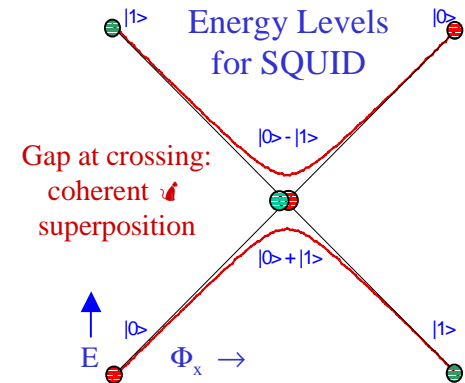
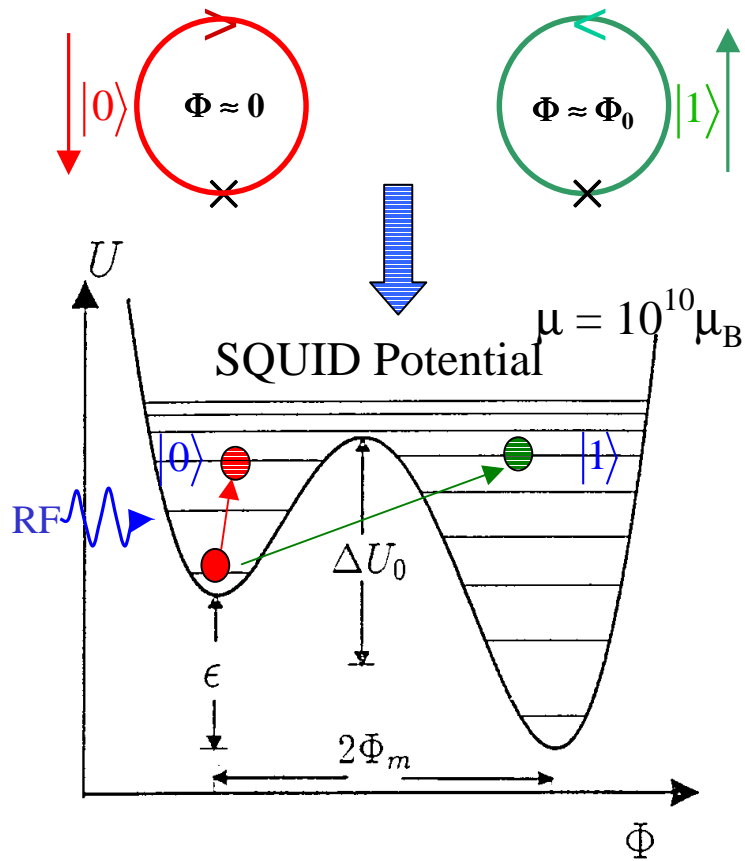

S. Chakravarty & S. Kivelson, PRL, **50**, 1811, (1983)

J. Friedman, *et al.*, Nature, **406**, 43 (July, 2000); C. Van der Wal, *et al.*, Science, 290, 773 (Oct. 2000)

Observed Peak Locations Compared to Best Fit Level Positions

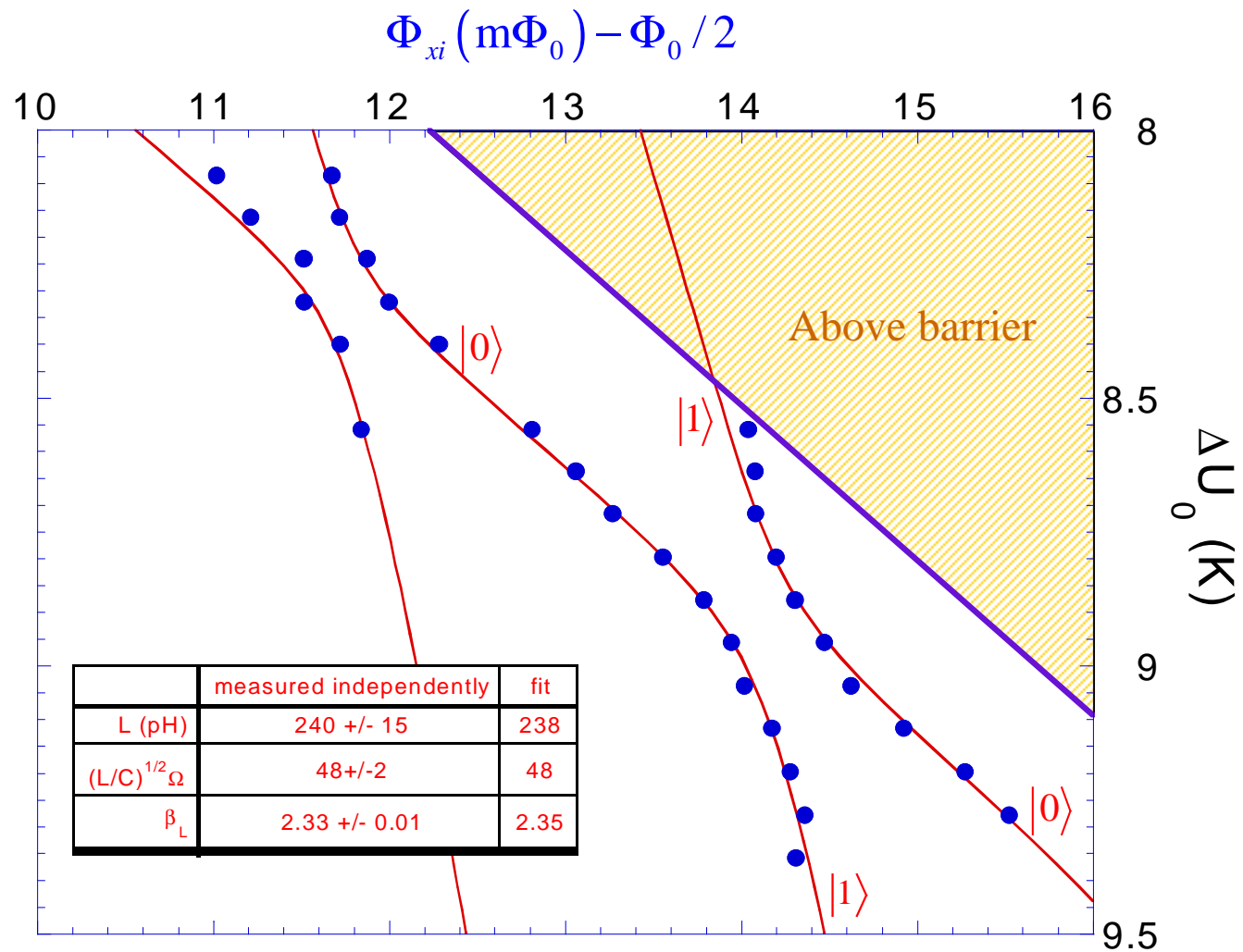

Quantum tunnelling in Mn₁₂-acetate

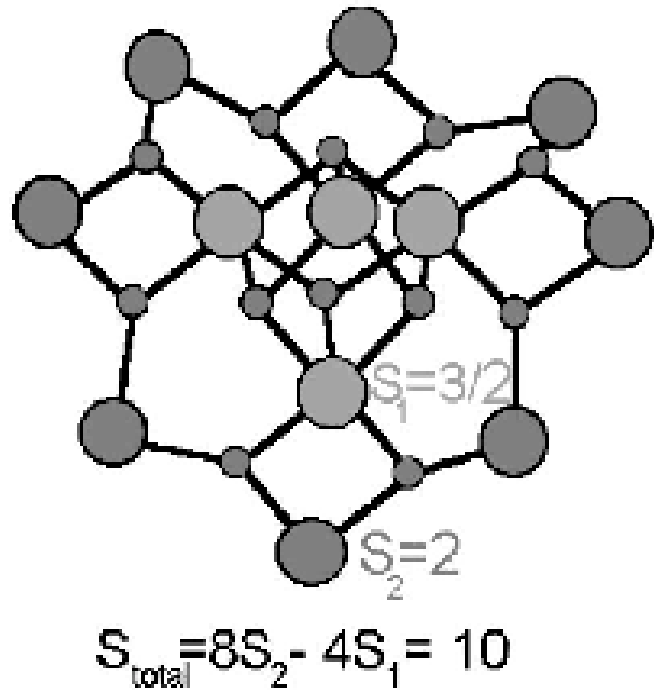

g. 1. Schematic representation of the molecule of Mn₁₂

L. Thomas, F. Lioni, R. Ballou, R. Sessoli, D. Gatteschi, and B. Barbara, *Nature (London)* **383**, 145 (1996).

J. R. Friedman, M. P. Sarachik, J. Tejada, and R. Ziolo, *Phys. Rev. Lett.* **76**, 3830 (1996)

$$H = -DS_z^2 - HS_z - AS_z^4 + H_{\text{tunnelling}}$$

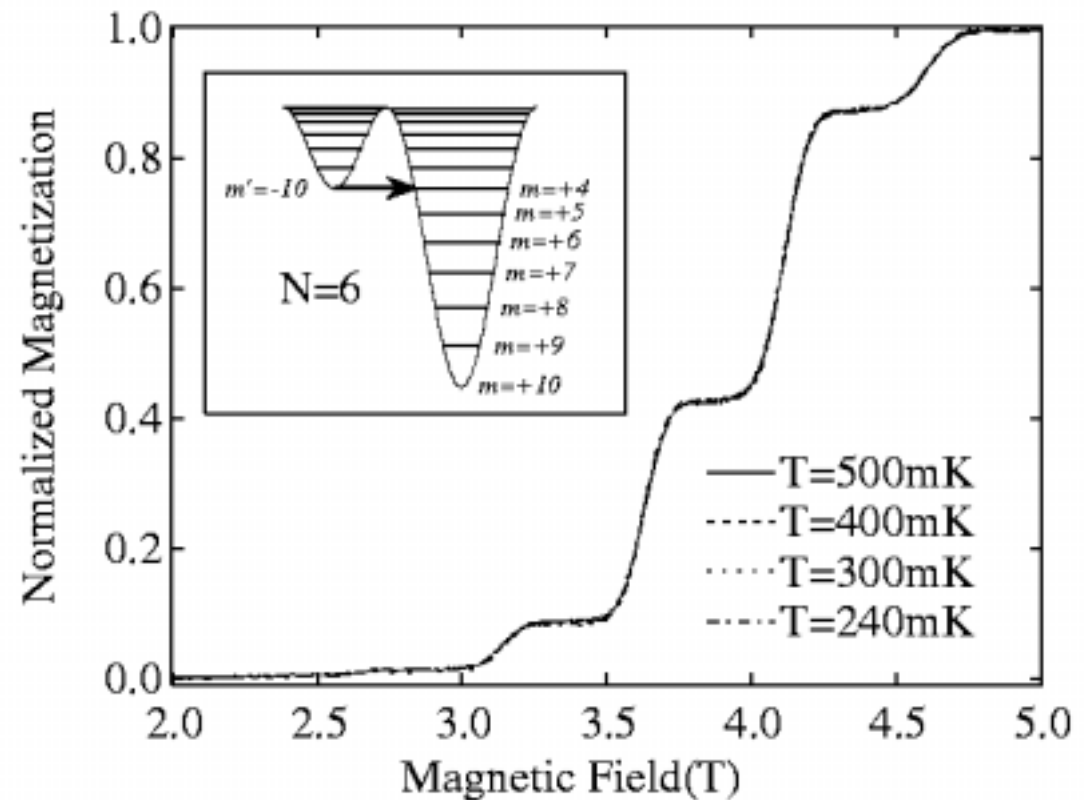

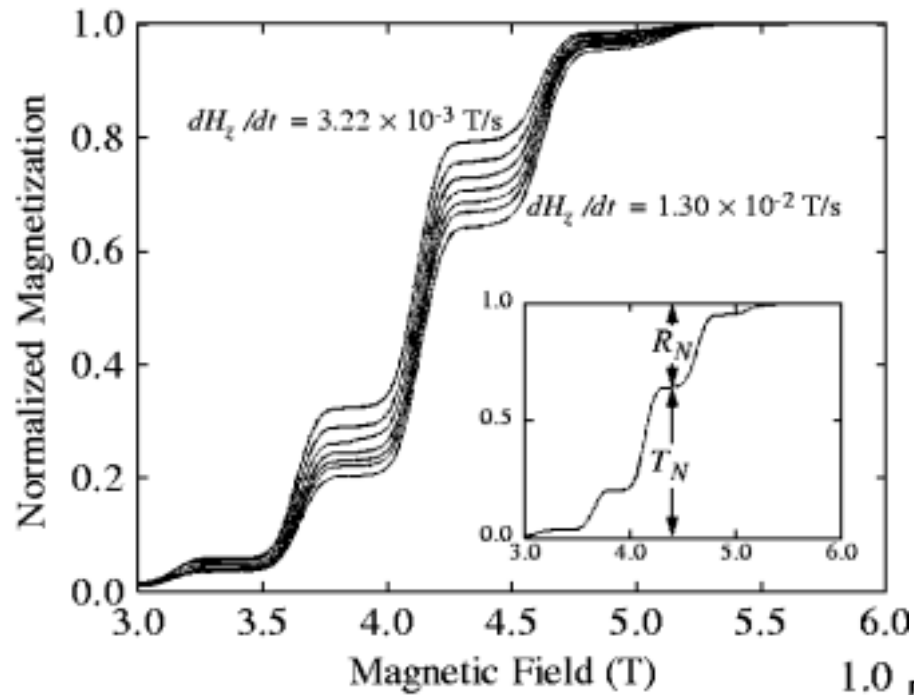

K. M. Mertes, Yoko Suzuki, and M. P. Sarachik, Y. Paltiel, H. Shtrikman, E. Zeldov, E. Rumberger D. N. Hendricksson, and G. Christou, Phys. Rev. Lett. **87**, 227205 (2001)

Distribution of tunnel splittings, Δ

Couplings between molecules ?

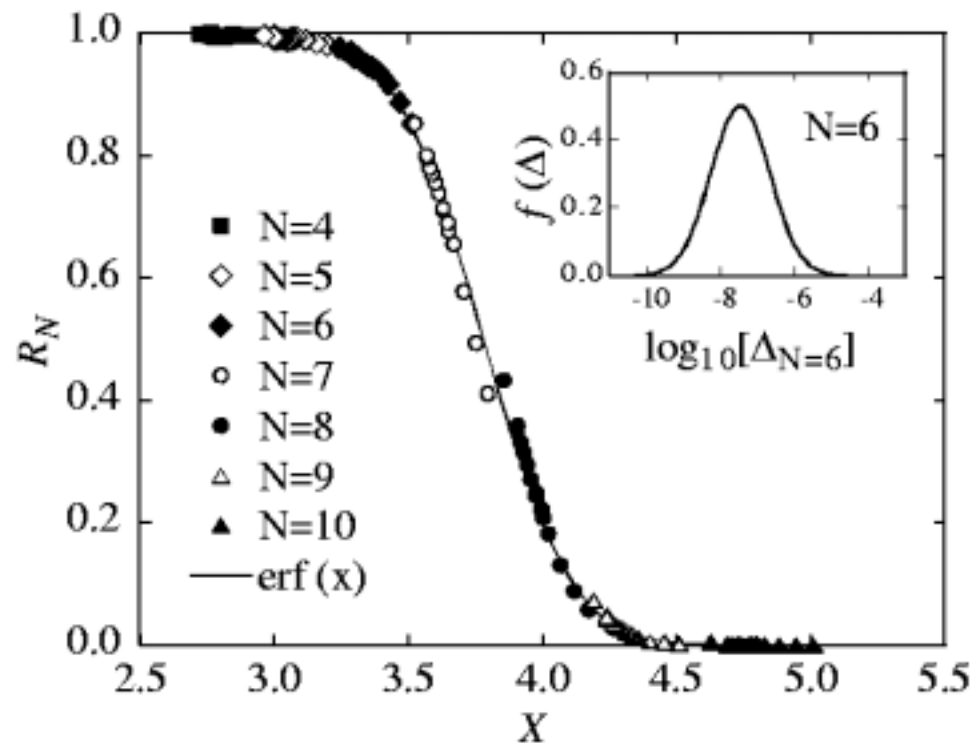

II. Single qubits with controlled dissipation.

(Paalanen, Haviland, Demler, Chakravarty, Chudnovsky)

RCSJ model for a Josephson junction:

$$H = E_C \left(\hat{n} + \frac{Q}{2e} \right)^2 - E_J \cos \hat{\phi} + H_{\text{dissipation}} \quad ; \quad [\hat{\phi}, \hat{n}] = i$$

$$\text{Voltage} = \frac{\partial H}{\partial Q} \quad ; \quad \text{Current} = \frac{dQ}{dt}$$

After integrating out degrees of freedom in $H_{\text{dissipation}}$ we obtain the following additional term in imaginary time action:

$$\frac{\alpha}{8\pi^2} \int d\tau d\tau' \frac{(\varphi(\tau) - \varphi(\tau'))^2}{(\tau - \tau')^2} \quad ; \quad \alpha = \frac{R_Q}{R}$$

$$\frac{E_J}{E_C}$$

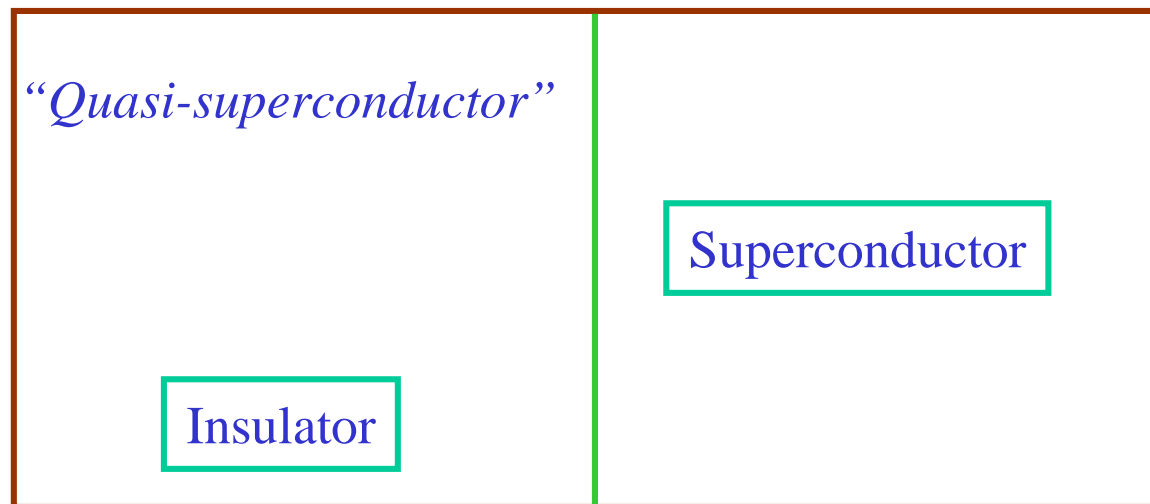

S. Chakravarty,
Phys. Rev. Lett. **49**,
681 (1982).

A. Schmid Phys.
Rev. Lett. **51**, 1506
(1983).

Haviland and Paalanen described experiments designed to examine the small α region.

Paalanen observed a zero-bias resistance $\sim T^{(2-2/\alpha)}$

Universal properties independent of E_J/E_C ?

Scaling as a function of voltage, frequency and temperature ?

Chudnovsky: microscopic model of decoherence by coupling of spins to lattice vibrations.

More info on this work is here.

III. Quantum phase transitions of coupled qubits.

(Kasevich, Zoller, Rosenbaum)

Cold bosons (or fermions) in an optical lattice

- Example: Bose Hubbard model

$$H = - \sum_{\alpha \neq \beta} J_{\alpha\beta} b_{\alpha}^{\dagger} b_{\beta} + \frac{1}{2} U \sum_{\alpha} b_{\alpha}^{\dagger} b_{\alpha}^{\dagger} b_{\alpha} b_{\alpha}$$

E_J ← kinetic energy: hopping interaction: onsite repulsion → E_C

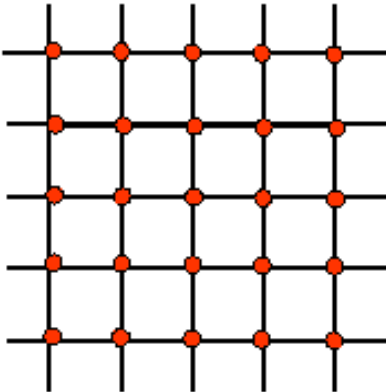

- realized by loading BEC into an optical lattice

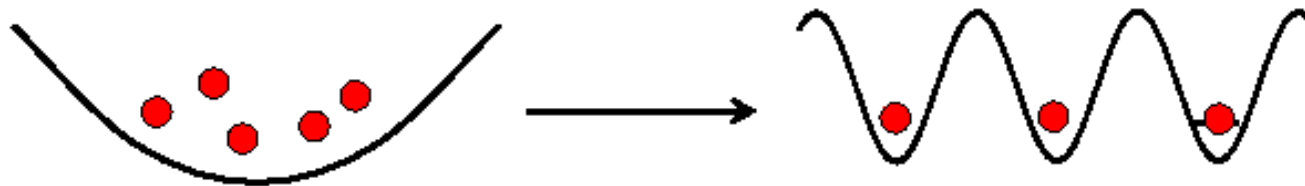

- system where we have ...
 - microscopic understanding
 - controllable parameters: laser
 - (small) decoherence
 - measurement

Kasevich – 30 lattice sites in one dimension, 50 atoms per site:
 Large E_J : Interference indicates phase correlations, as in a superconductor.
 Large E_C : Absence of interference indicates fixed number states,
 as in a Mott insulator

- Adiabatically (with respect to many-atom ground state) ramp lattice intensity to form squeezed states (200 msec).
- Switch off harmonic trap, hold for short time (2 msec) in gravitational potential (lattice beams vertically oriented).
- Release atoms from lattice. Observe interference of atoms released from lattice.

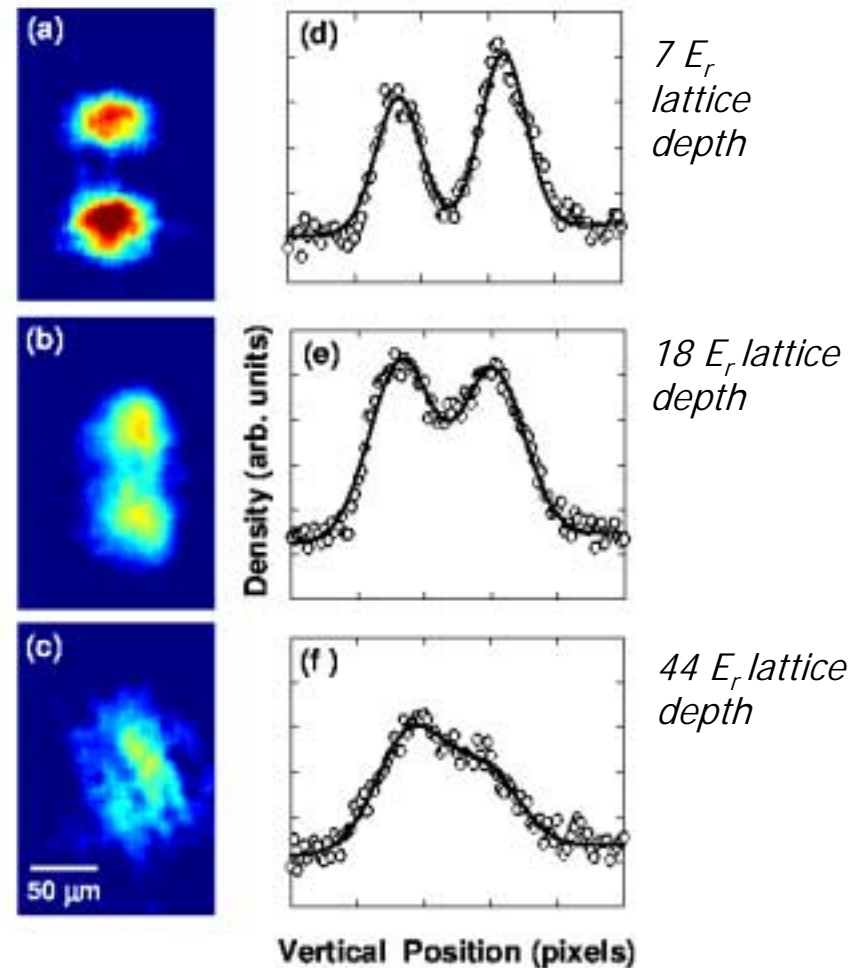

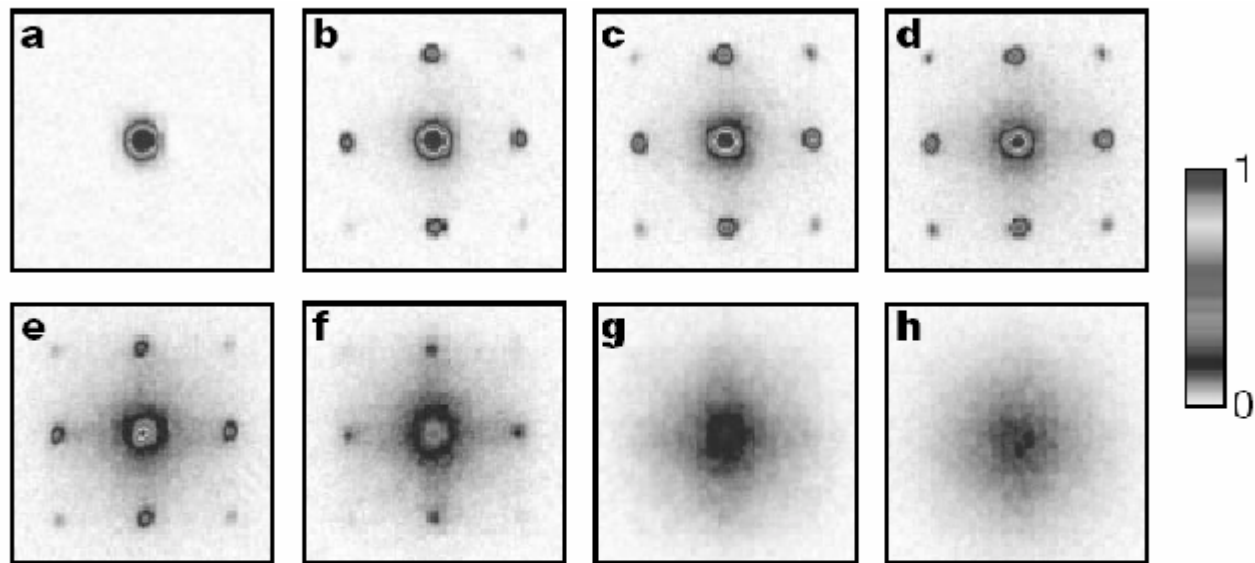
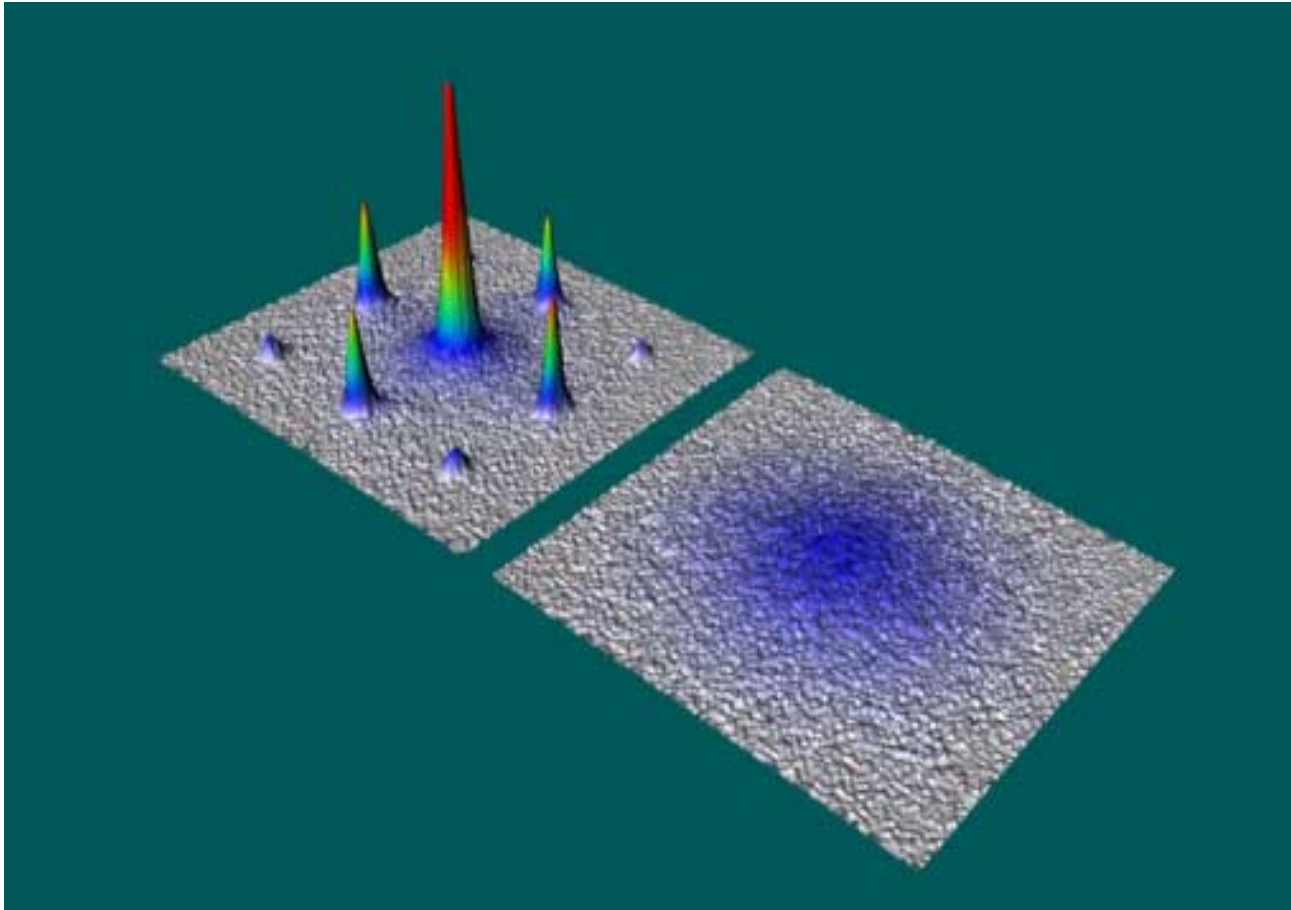

Figure 2 Absorption images of multiple matter wave interference patterns. These were obtained after suddenly releasing the atoms from an optical lattice potential with different potential depths V_0 after a time of flight of 15 ms. Values of V_0 were: **a**, $0 E_r$; **b**, $3 E_r$; **c**, $7 E_r$; **d**, $10 E_r$; **e**, $13 E_r$; **f**, $14 E_r$; **g**, $16 E_r$; and **h**, $20 E_r$.

I. Bloch, T. Hänsch et al., Nature Jan 3 2002

MI transition in 3D optical lattice. Approximately 3 atoms per lattice site.



I. Bloch, Nature,
2002.

Crossovers at nonzero temperature

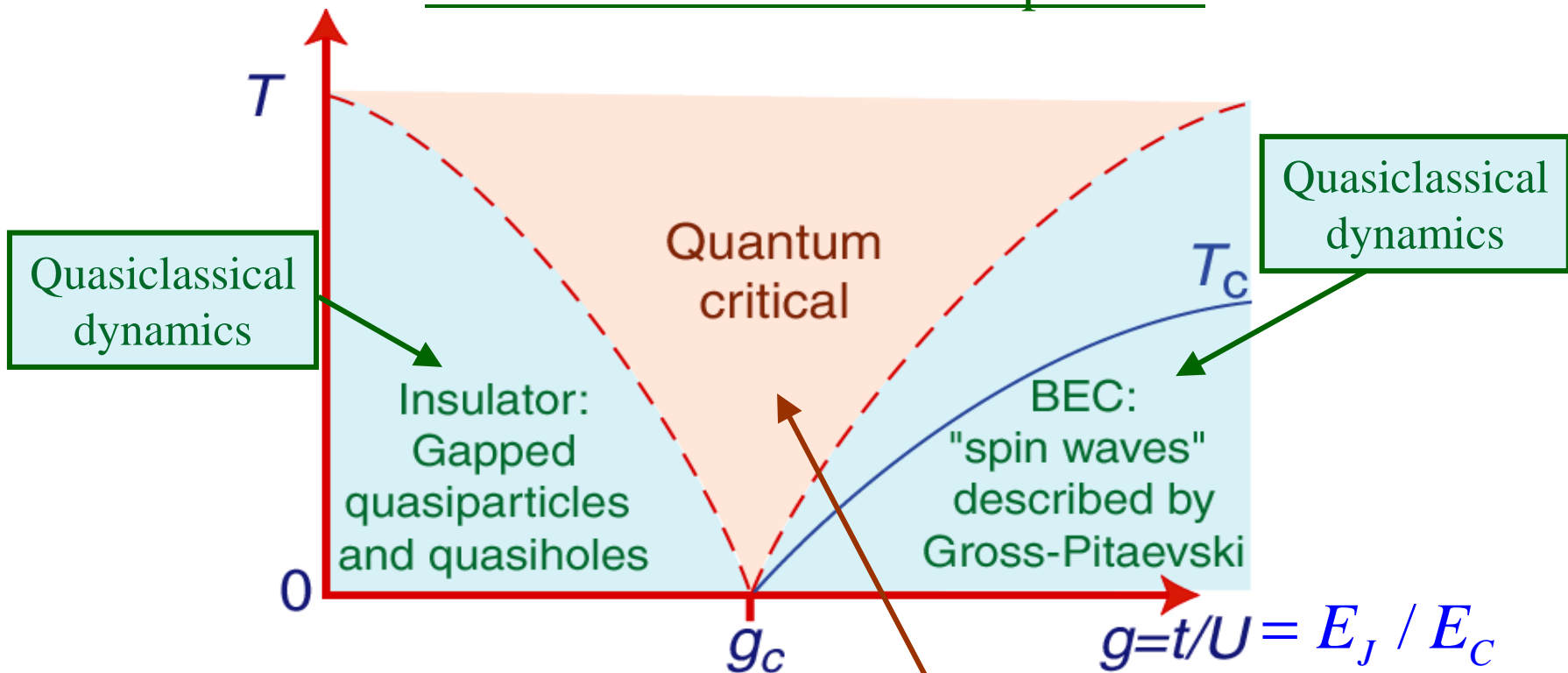

Relaxational dynamics ("Bose molasses") with phase coherence/relaxation time τ_ϕ given by

$$\frac{1}{\tau_\phi} = (\text{Universal number}) \frac{k_B T}{\hbar} \quad (1\mu\text{K} = 20.9\text{kHz})$$

S. Sachdev and J. Ye, *Phys. Rev. Lett.* **69**, 2411 (1992).
 K. Damle and S. Sachdev *Phys. Rev. B* **56**, 8714 (1997).

Conductivity (in d=2) = $\frac{Q^2}{h} \Sigma \left(\frac{\hbar\omega}{k_B T} \right)$ $\Sigma \rightarrow$ universal function

M.P.A. Fisher, G. Girvin, and G. Grinstein, *Phys. Rev. Lett.* **64**, 587 (1990).
 K. Damle and S. Sachdev *Phys. Rev. B* **56**, 8714 (1997).

Rosenbaum: $\text{LiHo}_x\text{Y}_{1-x}\text{F}_4$ - experimental realisation of Ising model in a transverse field

$$H_I = -E_J \sum_{\langle jk \rangle} J_{jk} \hat{\sigma}_j^z \hat{\sigma}_k^z - E_C \sum_j \hat{\sigma}_j^x$$

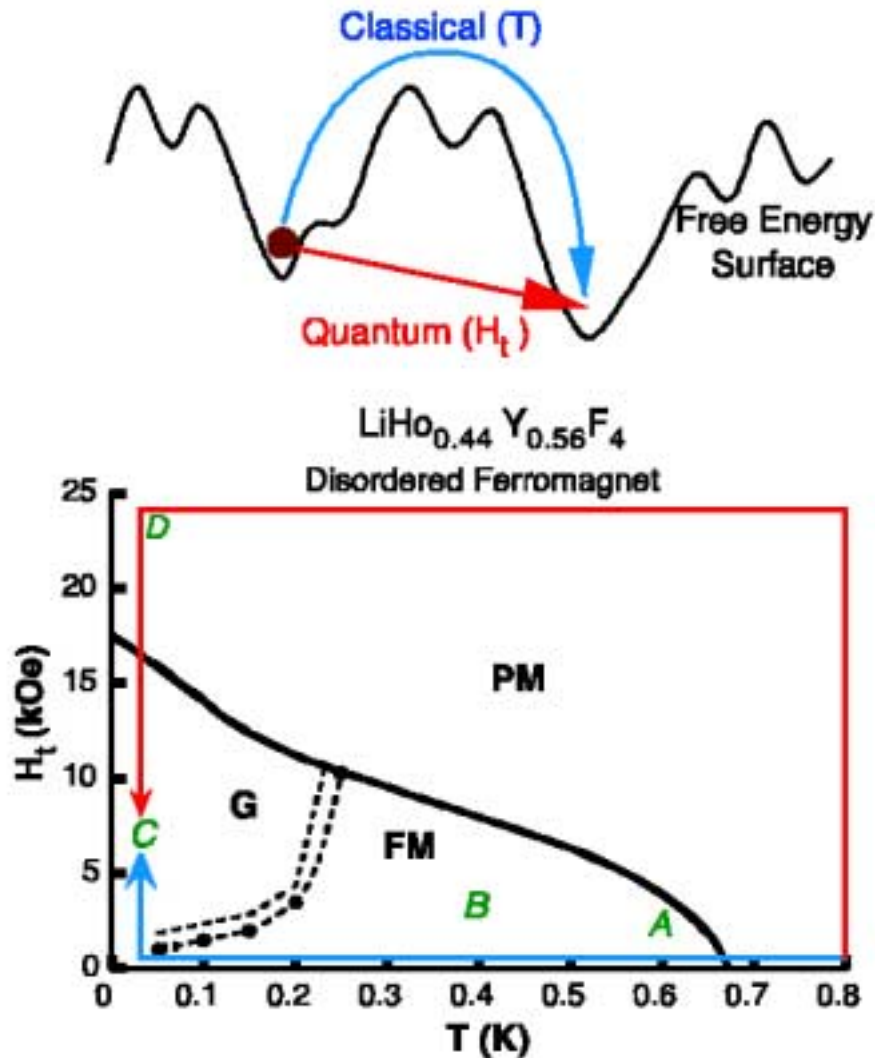

State obtained by “quantum cooling protocol” has fewer low energy excitations.

“Spectral hole burning” in dilute Ising spin system:
Coherent spin oscillation at a few Hz.

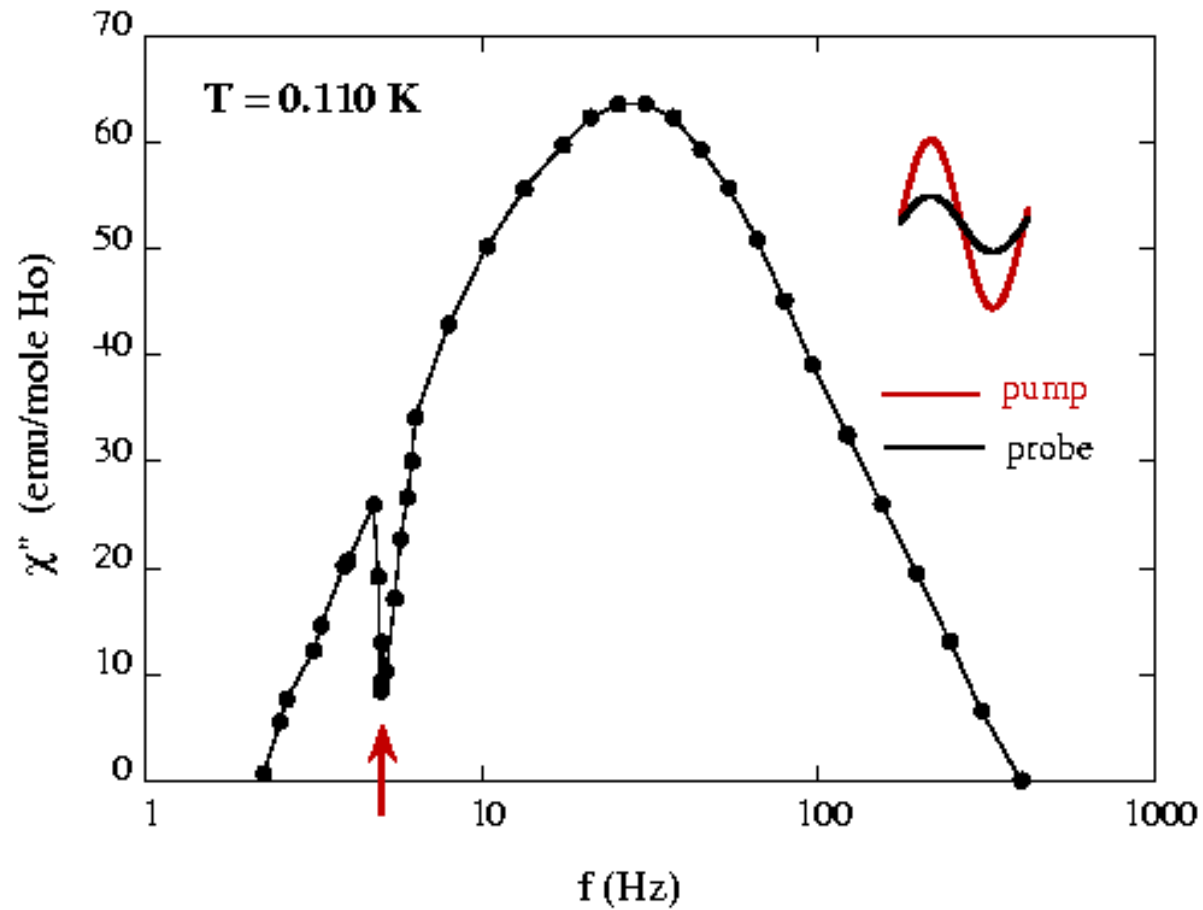

IV. Quantum phase transitions with microscopic dissipation.

(Shimshoni, Chakravarty, Demler)

Chakravarty: Lattice of coupled Josephson junctions, each with its own dissipative heat bath.

$$H = E_C \sum_j \hat{n}_j^2 - E_J \sum_{\langle jk \rangle} \cos(\hat{\phi}_j - \hat{\phi}_k) + H_{\text{dissipation}} \quad ; \quad [\hat{\phi}_j, \hat{n}_k] = i\delta_{jk}$$

Integrating out degrees of freedom in $H_{\text{dissipation}}$ yields the following additional term in imaginary time action:

$$\frac{\alpha}{8\pi^2} \sum_{\langle jk \rangle} \int d\tau d\tau' \frac{(\varphi_j(\tau) - \varphi_k(\tau) - \varphi_j(\tau') + \varphi_k(\tau'))^2}{(\tau - \tau')^2} \quad ; \quad \alpha = \frac{R_Q}{R}$$

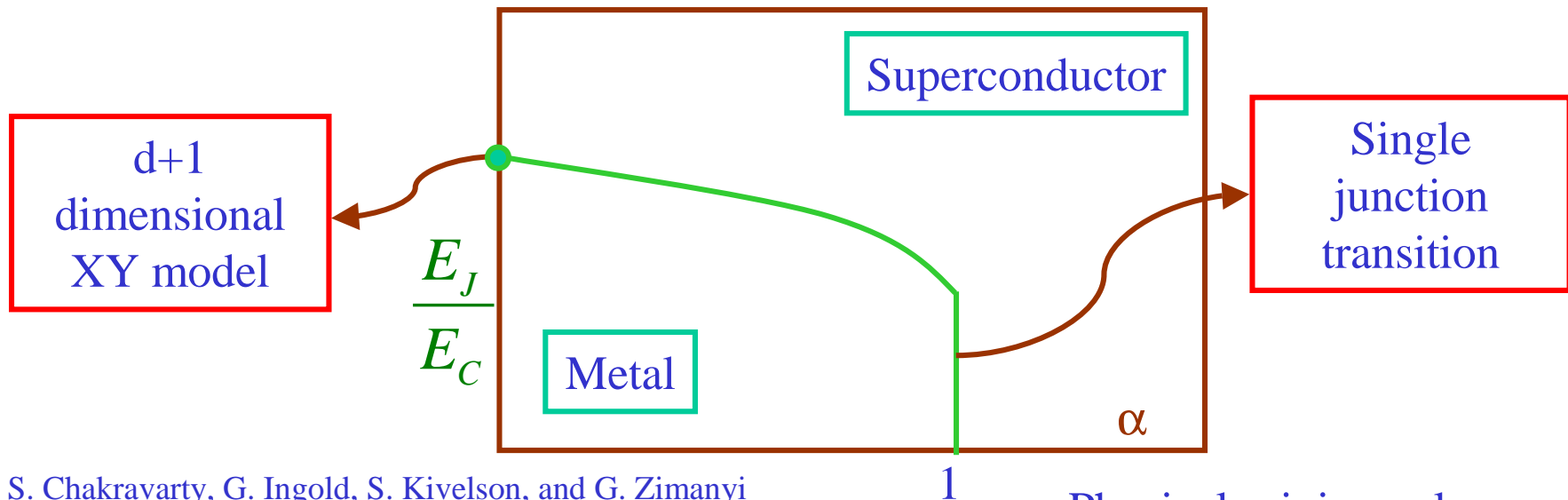

S. Chakravarty, G. Ingold, S. Kivelson, and G. Zimanyi
 Phys. Rev. B **37**, 3283-3294 (1988)

Physical origin unclear

Spivak : Superconducting grains in a metallic environment: spatial modulation of coupling between electrons cuts-off BCS logarithm

Order parameter: $\psi(x_j, \tau) \sim e^{i\phi_j(\tau)}$

Action for metal-superconductor transition:

$$S = \int d\tau \int d^2x \left[|\nabla_x \psi|^2 + r(x) |\psi|^2 + u |\psi|^4 \right] - \int d\tau d\tau' \frac{\psi(\tau) \psi^*(\tau') + \psi(\tau') \psi^*(\tau)}{(\tau - \tau')^2}$$

Maps onto Hertz theory for ordering transition of paramagnon modes in a Fermi liquid.

Dynamic exponent in the absence of disorder: $z=2$.

More work needed to understand transport properties and kinetic equation (Phillips and Dalidovich).

B. Spivak, A. Zyuzin, and M. Hruska, Phys. Rev. B **64**, 132502 (2001).

Shimshoni: Percolation model of metallic “puddles” in a superconducting environment.

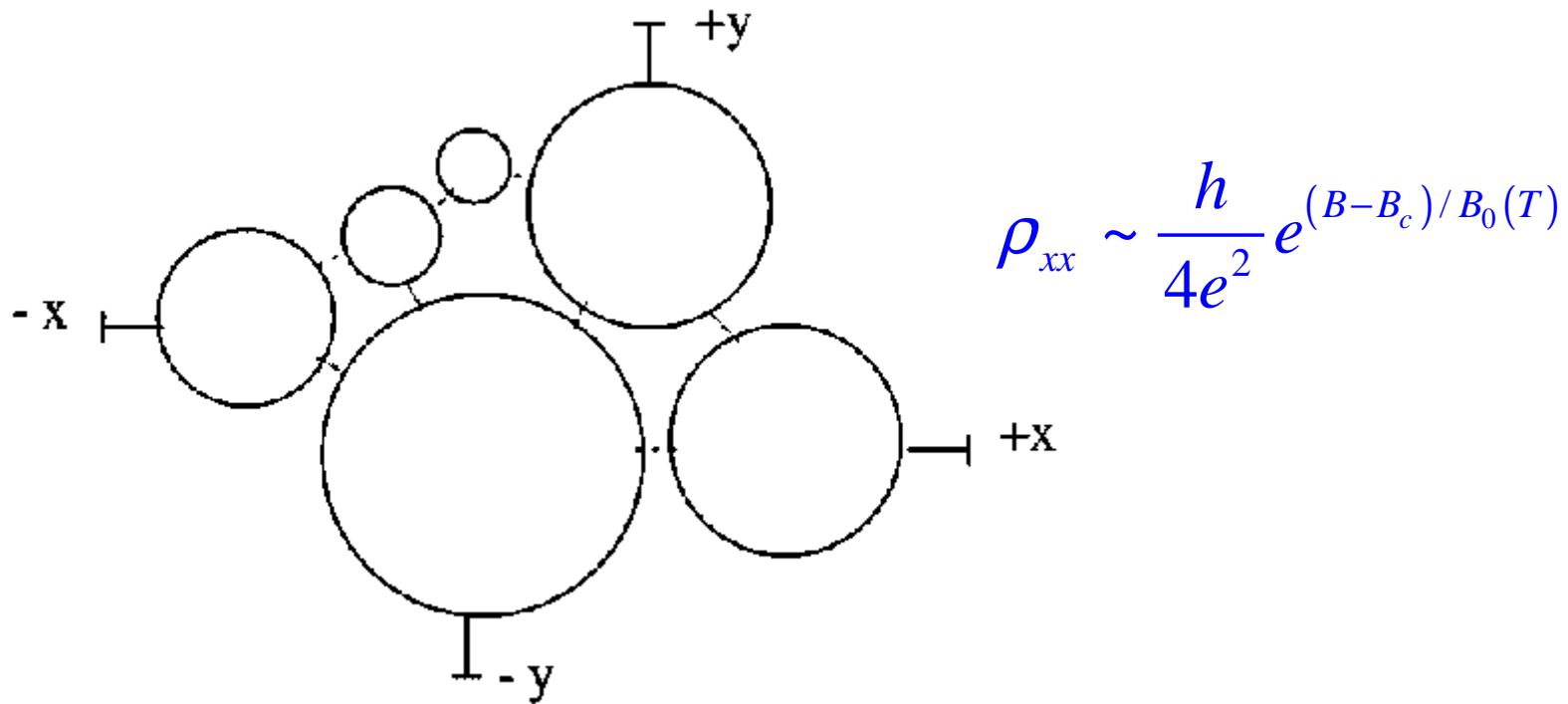

Classical equations for transport between puddles: requires finite dephasing length as temperature vanishes.

Provides good fit to longitudinal magnetoresistance in “metallic” phase between superconductor and insulator, and between quantum Hall plateaus.

Efrat Shimshoni, Assa Auerbach, and Aharon Kapitulnik, Phys. Rev. Lett. **80**, 3352 (1998)

V. Superconductor-(metal)-insulator and quantum Hall transitions.

(Tinkham, Kravchenko, Goldman, Mason, Shahar)

Tinkham: Resistance of thin superconducting wires. Phase slip events lead to finite resistance at all temperatures below the bulk critical temperature. Data explained by a model of statistically independent phase slip events occurring with probability

$$e^{-\Delta F / k_B T} \text{ (thermal activation)} + e^{-\Delta F / k_B T_c} \text{ (quantum tunnelling)}$$

Kravchenko: Experimental study of global phase diagram of quantum Hall effect. All results consistent with Jain's picture: "the fractional quantum Hall effect is the integer quantum Hall effect of composite fermions". Topology of phase diagram for the integer quantum Hall effect is mysterious: results disagree with the picture of "floating up" of extended states of Khmelnitskii and Laughlin. Apparent merging of extended states with decreasing field and a metallic state at zero field.

Goldman

Apparent superfluid-insulator transition.

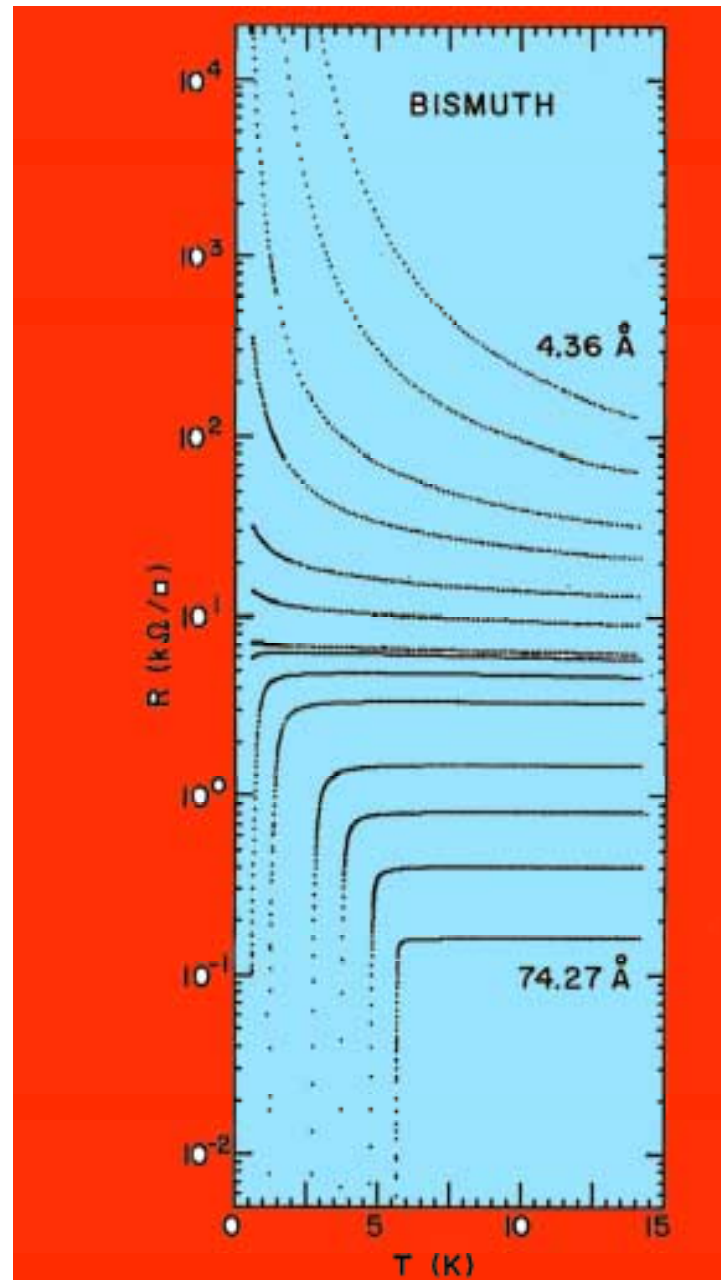

New system for quench-deposited films: apparent intermediate metallic state.

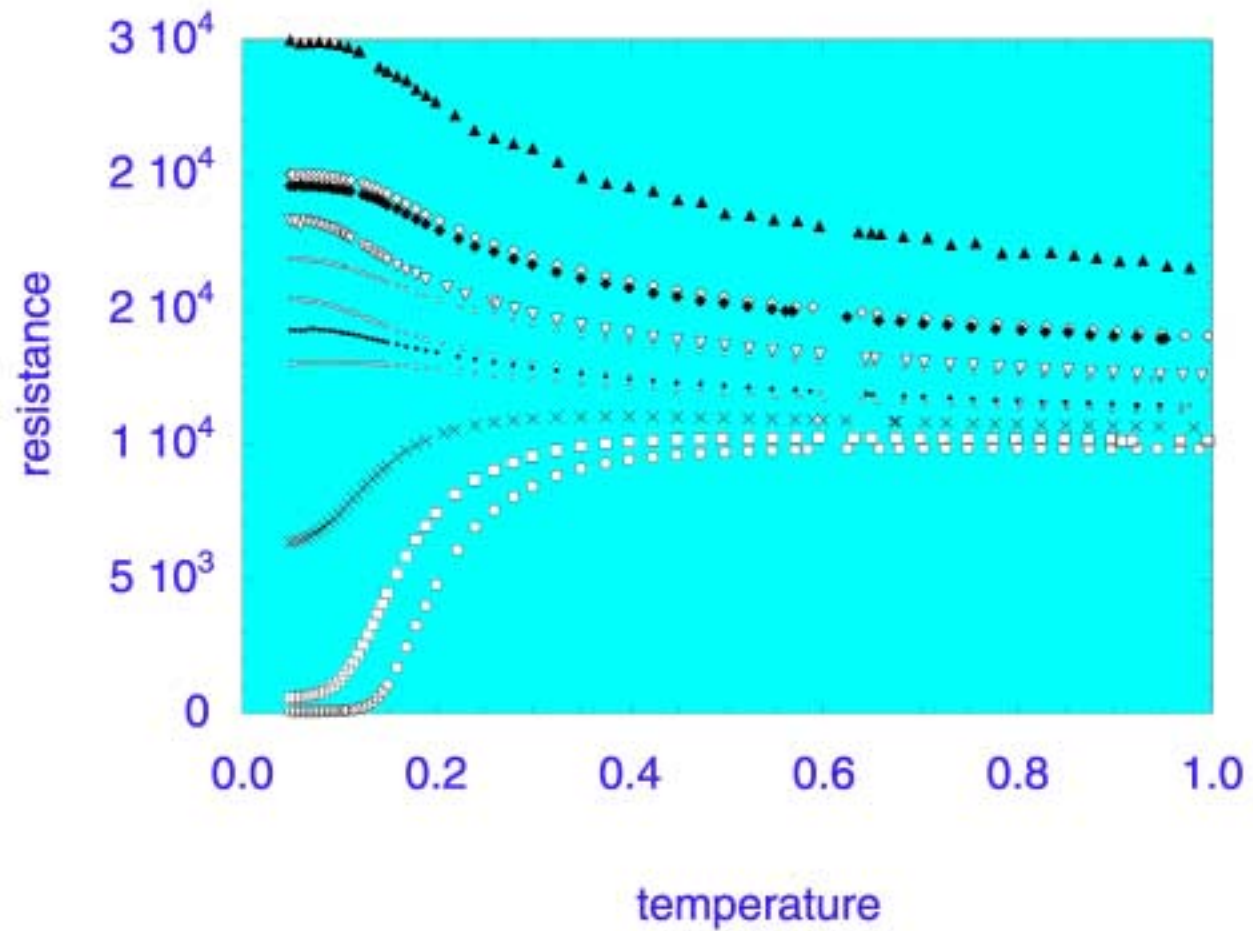

Mason:

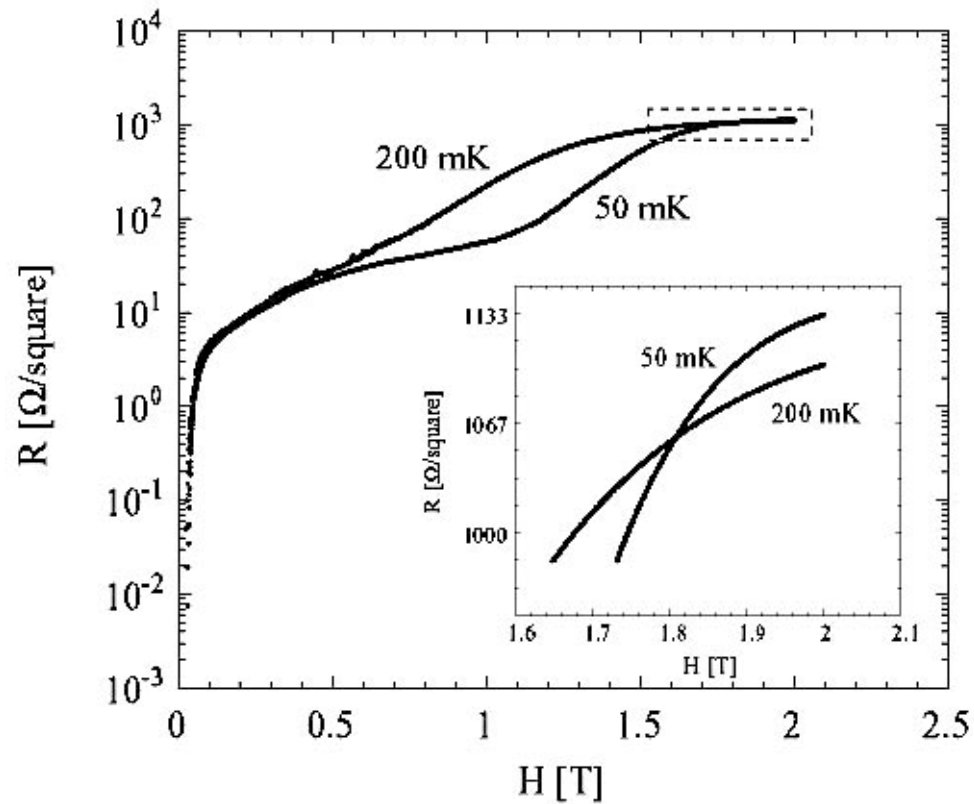

Evidence for an intermediate metallic state in the presence of an applied field. Conductance of metal is very high.

Effect of a ground plane.

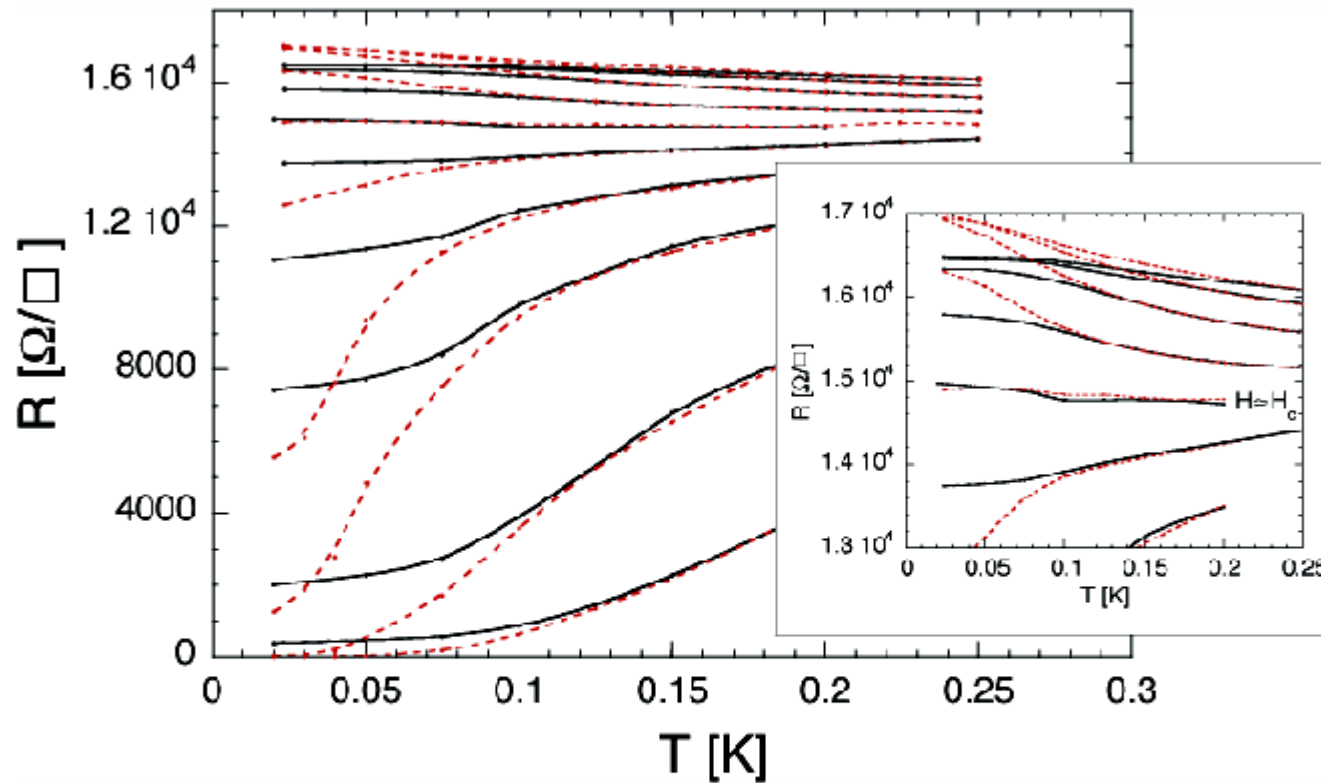

FIG. 3. Resistance versus temperature curves for bare (solid line) and ground plane (dashed line) samples. Main figure shows 30 \AA sample at $H=0.6, 0.8, 1.0, 1.1, 1.18, 1.25,$ and 1.5 Tesla. Inset shows 40 \AA sample at $H=1.7, 1.75, 1.8,$ and 2.0 Tesla.

Shahar:

Transport near quantum Hall transitions in mesoscopic samples.

$$\rho_{xx} \sim \frac{h}{e^2} e^{(v-v_c)/(a+bT)}$$

$$\rho_{xy} = \frac{h}{e^2} \text{ quantized independent of } \nu$$

Plateau width does not vanish as temperature goes to zero.

Measurements of conductance fluctuations as a function of temperature, system size, and filling factor.

VI. Decoherence in metals.

(Marcus, Gershenson, Birge, Willett)

τ_ϕ - phase coherence time: more properly it is the cut-off time for interference effects between time-reversed quasiparticle paths in a disordered metallic states: *cf.* this cut-off time includes a contribution from spin-orbit scattering. Other quantum states with different elementary excitations need different definitions of phase coherence times.

Gershenson: Measurements of τ_ϕ in metallic wires and films. All agree with the theoretical prediction:

$$\frac{\hbar}{\tau_\phi} \sim \frac{k_B T}{g(L_\phi)}$$

Theory breaks down when $g(L_\phi) \sim 1$; strong localization with hopping conduction at smaller values of g

Birge:

- Careful investigation of low temperature saturation of τ_ϕ in thin wires of Ag, Cu, Au.
- Saturation in magnetoresistance measurements might be due to magnetic impurities with $T_K < 0.1$ K and concentration less than 1 ppm.
- Measurements of energy distribution function of electrons by tunnelling from a superconductor into wires lead to (in Cu, Au) a collision kernel

$$K(\varepsilon) \sim \frac{\tau_0^{-1}}{\varepsilon^2}$$

Explained by Kondo scattering (Kaminsky and Glazman)

- Field dependence of Aharonov-Bohm oscillations also consistent with magnetic impurity model.

Willet: magnetoresistance in ultra-thin metallic wires. No saturation of τ_ϕ in 5 nanometer wires, and temperature dependence consistent with theory. Thicker wires display saturation from “impurities”.

Marcus: Conductance fluctuations and Coulomb blockade in quantum dots lead to measurements of τ_ϕ . Saturation at low T cannot be explained by spin-orbit scattering.

Speculation: Kondo scattering from “Griffiths effects” in interacting electron gas. Electronic local moments form due to fluctuations in local environment.

e.g. weak bonds in a Hubbard model.

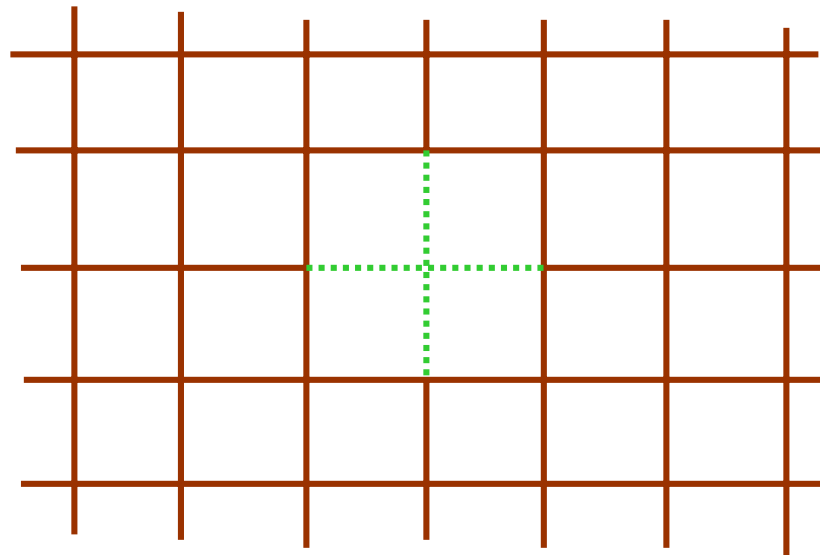

VII. Other talks.

(Cirac, Lukin, Clarke, Chemla, Yamamoto)

Cirac: Possible fractional quantum Hall states in rotating BEC systems allow observation of fractional statistics.

Lukin: Dark states in quantum optics --- creation of coherent states by dissipative effects.

Clarke: Design of a low noise flux detector: the INSQUID

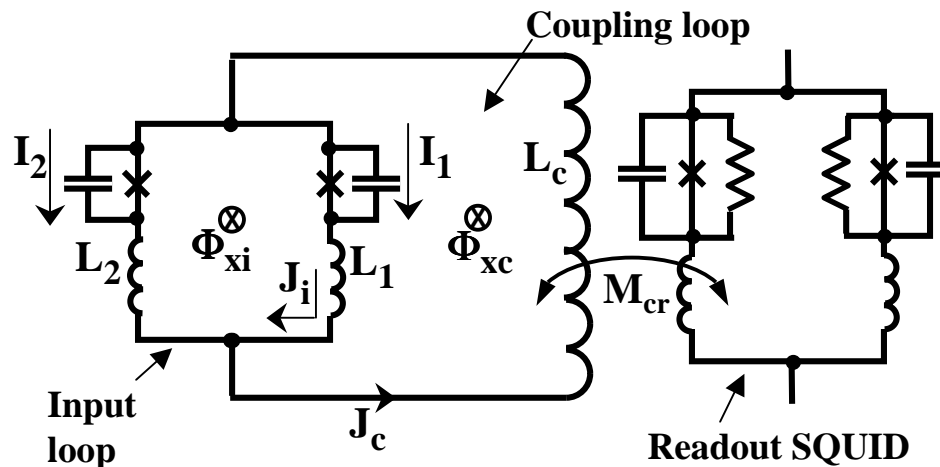

Chemla: Trapping of 700000 degenerate excitons collapsing in a 24 μm trap

Yamamoto: quantum computation by NMR

VIII. Conclusions.

Thanks to

Aharon Kapitulnik and Eugene Demler